



DECLARATION OF PERFORMANCE



No. 0025 – EN

1. Unique identification code of the product-type: **fischer injection system FIS P Plus masonry**

2. Intended use/es:

| Product                                    | Intended use/es  |
|--|--|
| Metal injection anchors for use in masonry | Anchorage for which requirements for mechanical resistance and stability and safety in use shall be fulfilled. They are for fixing and/or supporting structural elements (which contribute to the stability of the works) or heavy units, see appendix, especially Annexes B 1 to B 10 |

3. Manufacturer: **fischerwerke GmbH & Co. KG, Klaus-Fischer-Straße 1, 72178 Waldachtal, Germany**

4. Authorised representative: --

5. System/s of AVCP: **1**

6a. Harmonised standard: ---

Notified body/ies: ---

6b. European Assessment Document: **ETAG 029; 2013-04**

European Technical Assessment: **ETA-11/0419; 2015-10-30**

Technical Assessment Body: **DIBt**

Notified body/ies: **1343 – MPA Darmstadt**

7. Declared performance/s:

**Mechanical resistance and stability (BWR 1)**

| Essential characteristic                               | Performance                                 |
|--|---|
| Characteristic resistance for tension and shear loads  | See appendix, especially Annexes C 1 to C 4 |
| Characteristic resistance for bending moments          | See appendix, especially Annex C 5          |
| Displacements under shear and tension loads            | See appendix, especially Annex C 5          |
| Reduction Factor for job site tests ( $\beta$ -Factor) | See appendix, especially Annex C 6          |
| Edge distances and spacing                             | See appendix, especially Annexes C 7 to C 8 |

**Safety in case of fire (BWR 2)**

| Essential characteristic | Performance                                  |
|--------------------------|--|
| Reaction to fire         | Anchorage satisfy requirements for Class A 1 |
| Resistance to fire       | NPD  |

8. Appropriate Technical Documentation and/or Specific Technical Documentation: ---

The performance of the product identified above is in conformity with the set of declared performance/s. This declaration of performance is issued, in accordance with Regulation (EU) No 305/2011, under the sole responsibility of the manufacturer identified above.

Signed for and on behalf of the manufacturer by:

Andreas Bucher, Dipl.-Ing.

Wolfgang Hengesbach, Dipl.-Ing., Dipl.-Wirtsch.-Ing.

Tumlingen, 2015-11-06

- This DoP has been prepared in different languages. In case there is a dispute on the interpretation the english version shall always prevail.

- The Appendix includes voluntary and complementary information in English language exceeding the (language-neutrally specified) legal requirements.

## Specific Part

### 1 Technical description of the product

The fischer injectionsystem FIS P Plus for masonry is a bonded anchor (injection type) consisting of a mortar cartridge with injection mortar fischer FIS P Plus, FIS P Plus Low Speed and FIS P Plus High Speed, a perforated sieve sleeve and an anchor rod with hexagon nut and washer or an internal threaded rod. The steel elements are made of zinc coated steel, stainless steel or high corrosion resistant steel.

The anchor rod is placed into a drilled hole filled with injection mortar and is anchored via the bond between steel element, injection mortar and masonry and mechanical interlock.

The product description is given in Annex A.

### 2 Specification of the intended use in accordance with the applicable European Assessment Document

The performances given in Section 3 are only valid if the anchor is used in compliance with the specifications and conditions given in Annex B.

The verifications and assessment methods on which this European Technical Assessment is based lead to the assumption of a working life of the anchor of at least 50 years. The indications given on the working life cannot be interpreted as a guarantee given by the producer, but are to be regarded only as a means for choosing the right products in relation to the expected economically reasonable working life of the works.

### 3 Performance of the product and references to the methods used for its assessment

#### 3.1 Mechanical resistance and stability (BWR 1)

| Essential characteristic                               | Performance         |
|--|---------------------|
| Characteristic resistance for tension and shear loads  | See Annex C 1 – C 4 |
| Characteristic resistance for bending moments          | See Annex C 5       |
| Displacements under shear and tension loads            | See Annex C 5       |
| Reduction Factor for job site tests ( $\beta$ -Factor) | See Annex C 6       |
| Edge distances and spacing                             | See Annex C 7 – C8  |

#### 3.2 Safety in case of fire (BWR 2)

| Essential characteristic | Performance                                 |
|--------------------------|---|
| Reaction to fire         | Anchorage satisfy requirements for Class A1 |
| Resistance to fire       | No performance assessed                     |

#### 3.3 Hygiene, health and the environment (BWR 3)

Regarding dangerous substances there may be requirements (e.g. transposed European legislation and national laws, regulations and administrative provisions) applicable to the products falling within the scope of this European Technical Assessment. In order to meet the provisions of Regulation (EU) No 305/2011, these requirements need also to be complied with, when and where they apply.

**3.4 Safety in use (BWR 4)**

The essential characteristics regarding Safety in use are included under the Basic Works Requirement Mechanical resistance and stability.

**4 Assessment and verification of constancy of performance (AVCP) system applied, with reference to its legal base**

In accordance with guideline for European technical approval ETAG 029, April 2013 used as European Assessment Document (EAD) according to Article 66 Paragraph 3 of Regulation (EU) No 305/2011 the applicable European legal act is: [97/177/EC].

The system to be applied is: 1

**Installation conditions part 1;**

**Threaded rods with perforated sleeve FIS H K; Installation in perforated and solid brick masonry**

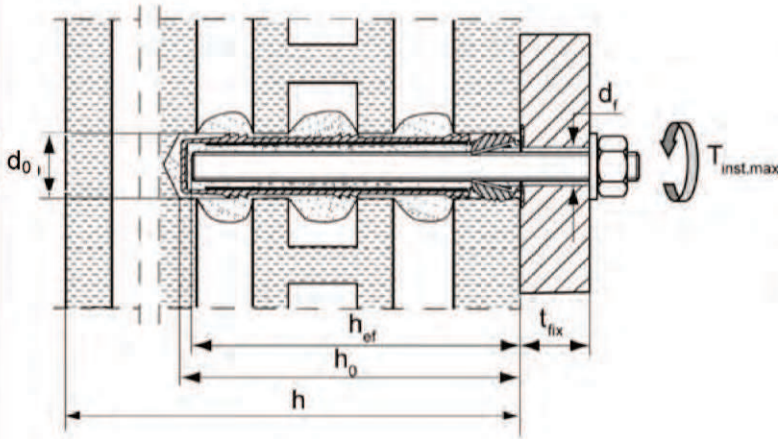

**Pre-positioned installation**

- FIS H 12x85 K
- FIS H 16x85 K
- FIS H 16x130 K
- FIS H 20x85 K
- FIS H 20x130 K
- FIS H 20x200 K

**Internal threaded anchors FIS E with perforated sleeve FIS H K; Installation in perforated and solid brick masonry**

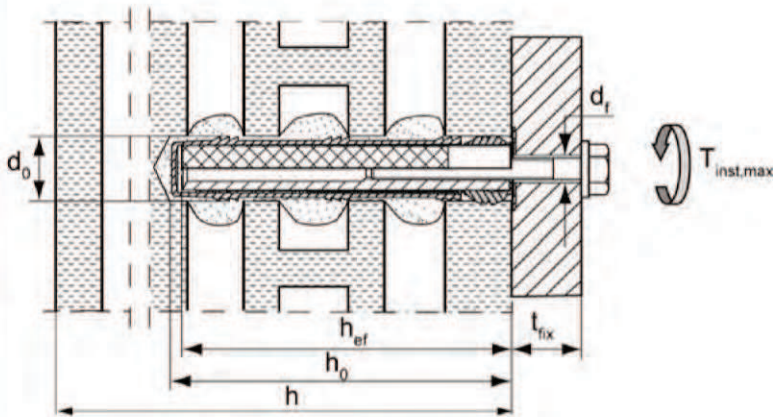

**Pre-positioned installation**

- FIS H 16x85 K – FIS E 11x85 M6 and M8
- FIS H 20x85 K- FIS E 15x85 M10 and M12

$h_{ef}$  = effective anchorage depth  
 $h_0$  = depth of drill hole  
 $t_{fix}$  = thickness of fixture  
 $h$  = thickness of masonry

$d_0$  = nominal drill bit diameter  
 $d_1$  = diameter of clearance hole in the fixture  
 $T_{inst,max}$  = maximum torque moment

**fischer Injectionsystem FIS P Plus for masonry**

**Product description**

Installation condition, part 1: in perforated and solid brick masonry

**Annex A 1**

**Installation conditions part 2;**

**Threaded rods without perforated sleeve FIS H K; Installation in solid brick masonry and autoclaved aerated concrete**

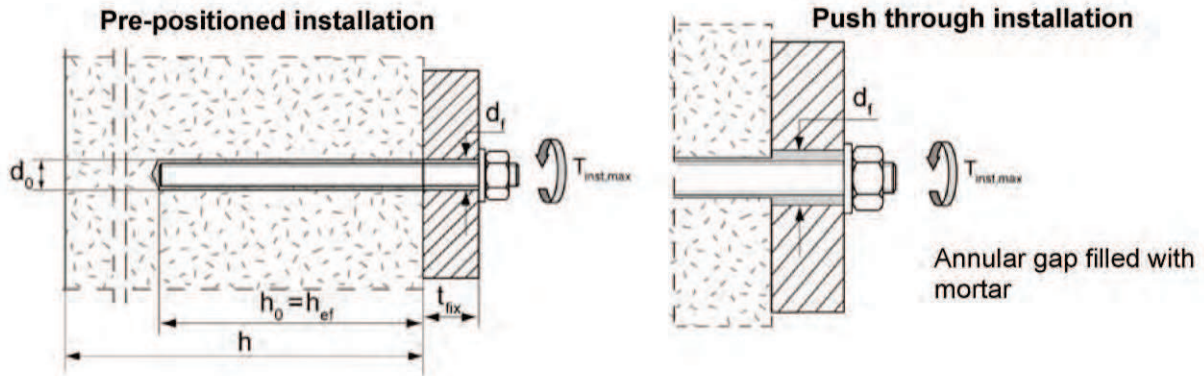

**Internal threaded anchors FIS E without perforated sleeve FIS H K; Installation in solid brick masonry and autoclaved aerated concrete**

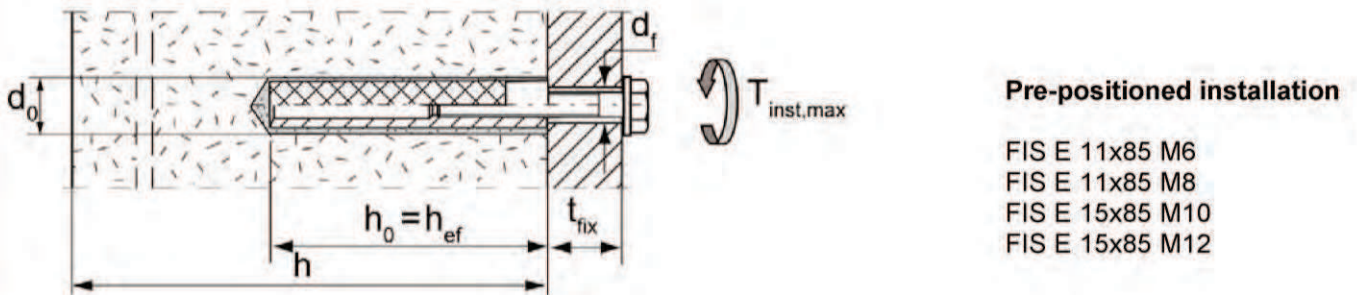

$h_{ef}$  = effective anchorage depth  
 $h_0$  = depth of drill hole  
 $t_{fix}$  = thickness of fixture  
 $h$  = thickness of masonry

$d_0$  = nominal drill bit diameter  
 $d_f$  = diameter of clearance hole in the fixture  
 $T_{inst,max}$  = maximum torque moment

**fischer Injectionsystem FIS P Plus for masonry**

**Product description**

Installation condition, part 2: in solid brick masonry and aerated concrete

**Annex A 2**

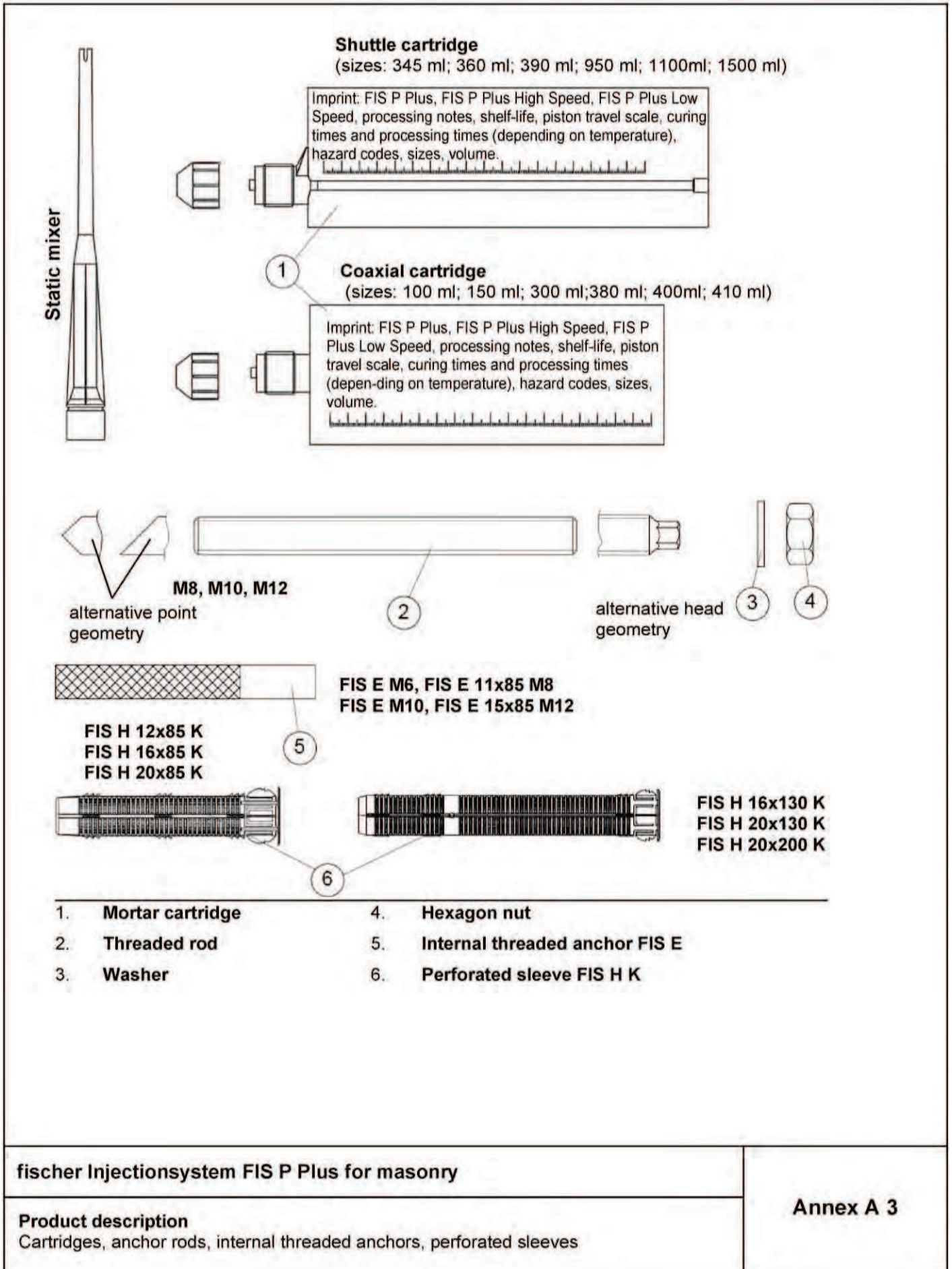

fischer Injectionsystem FIS P Plus for masonry

**Product description**

Cartridges, anchor rods, internal threaded anchors, perforated sleeves

**Annex A 3**

**Table A1: Materials**

| <b>Part</b> | <b>Designation</b>   | <b>Material</b>  |  |  |
|-------------|--|--|--|--|
| 1           | Mortar cartridge   | mortar, hardener; filler   |  |  |
|             |  | Steel, zinc plated   | Stainless steel A4   | High corrosion-resistant steel C   |
| 2           | Threaded rod   | Property class 5.8 or 8.8;<br>EN ISO 898-1:2013<br>zinc plated $\geq 5\mu\text{m}$ ,<br>EN ISO 4042:1999<br>A2K or hot-dip galvanised<br>EN ISO 10684:2004<br>$f_{uk} \leq 1000 \text{ N/mm}^2$<br>$A_5 > 8\%$ | Property class 50, 70<br>or 80<br>EN ISO 3506:2009<br>1.4401; 1.4404;<br>1.4578; 1.4571;<br>1.4439; 1.4362;<br>1.4062<br>EN 10088-1:2014<br>$f_{uk} \leq 1000 \text{ N/mm}^2$<br>$A_5 > 8\%$ | Property class 50 or 80<br>EN ISO 3506:2009<br>or property class 70<br>with $f_{yk} = 560 \text{ N/mm}^2$<br>1.4565; 1.4529<br>EN 10088-1:2014<br>$f_{uk} \leq 1000 \text{ N/mm}^2$<br>$A_5 > 8\%$ |
| 3           | Washer<br>ISO 7089:2000  | zinc plated $\geq 5\mu\text{m}$ ,<br>EN ISO 4042:1999 A2K<br>or hot-dip galvanised<br>ISO 10684:2004   | 1.4401; 1.4404;<br>1.4578; 1.4571;<br>1.4439; 1.4362<br>EN 10088-1:2014  | 1.4565; 1.4529<br>EN 10088-1:2014  |
| 4           | Hexagon nut  | Property class 5 or 8;<br>EN ISO 898-2:2013<br>zinc plated $\geq 5\mu\text{m}$ ,<br>ISO 4042:1999 A2K<br>or hot-dip galvanised<br>ISO 10684:2004   | Property class 50, 70<br>or 80<br>ISO 3506:2009<br>1.4401; 1.4404;<br>1.4578; 1.4571;<br>1.4439; 1.4362<br>EN 10088-1:2014   | Property class 50, 70 or<br>80<br>ISO 3506:2009<br>1.4565; 1.4529<br>EN 10088-1:2014   |
| 5           | Internal threaded anchor<br>FIS E                              | Property class 5.8;<br>EN 10277-1:2008<br>zinc plated $\geq 5\mu\text{m}$ ,<br>EN ISO 4042:1999 A2K  | Property class 70<br>EN ISO 3506:2009<br>1.4401; 1.4404;<br>1.4578; 1.4571;<br>1.4439; 1.4362<br>EN 10088-1:2014   | Property class 70<br>EN ISO 3506-1:2009<br>1.4565; 1.4529<br>EN 10088-1:2014   |
|             | Screw or threaded rod for<br>internal threaded anchor<br>FIS E | Property class 5.8 or 8.8;<br>EN ISO 898-1:2013<br>zinc plated $\geq 5\mu\text{m}$ ,<br>ISO 4042:1999 A2K  | Property class 70<br>EN ISO 3506:2009<br>1.4401; 1.4404;<br>1.4578; 1.4571;<br>1.4439; 1.4362<br>EN 10088-1:2014   | Property class 70<br>EN ISO 3506-1:2009<br>1.4565; 1.4529<br>EN 10088-1:2014   |
| 6           | Perforated sleeve<br>FIS H K                                   | PP / PE  |  |  |

fischer Injectionsystem FIS P Plus for masonry

Product description  
Materials

Annex A 4

**Specifications of intended use part 1**

**Anchorage subject to:**

- Static and quasi-static loads

**Base materials:**

- Solid brick masonry (Use category b) and autoclaved aerated concrete (Use category d), acc. to Annex B8.  
Note: The characteristic resistance is also valid for larger brick sizes and higher compressive strength of the masonry unit.
- Hollow brick masonry (use category c), according to Annex B8
- Mortar strength class of the masonry M2,5 at minimum according to EN 998-2:2010
- For other bricks in solid masonry, hollow or perforated masonry and autoclaved aerated concrete, the characteristic resistance of the anchor may be determined by job site tests according to ETAG 029, Annex B under consideration of the  $\beta$ -factor according to Annex C6, Table C4

**Temperature Range:**

- I: From - 40°C to +80°C (max. short term temperature +80°C and max. long term temperature +50°C)

**Use conditions (Environmental conditions):**

- Dry and wet structure (regarding injection mortar)
- Structures subject to dry internal conditions exist  
(zinc coated steel, stainless steel or high corrosion resistant steel)
- Structures subject to external atmospheric exposure including industrial and marine environment or exposure to permanently damp internal condition, if no particular aggressive conditions exist  
(stainless steel or high corrosion resistant steel)
- Structures subject to external atmospheric exposure and to permanently damp internal condition, if other particular aggressive conditions exist (high corrosion resistant steel)  
Note: Particular aggressive conditions are e.g. permanent, alternating immersion in seawater or the splash zone of seawater, chloride atmosphere of indoor swimming pools or atmosphere with extreme chemical pollution (e.g. in desulphurization plants or road tunnels where de-icing materials are used)

**fischer Injectionsystem FIS P Plus for masonry**

**Intended Use**  
Specifications part 1

**Annex B 1**



## Specifications of intended use part 2

### Design:

- The anchorages have to be designed in accordance with the ETAG 029, Annex C, Design method A under the responsibility of an engineer experienced in anchorages and masonry work

Applies to all bricks, if no other values are specified:

$$N_{Rk} = N_{Rk,s} = N_{Rk,p} = N_{Rk,b} = N_{Rk,pb}$$

$$V_{Rk} = V_{Rk,s} = V_{Rk,b} = V_{Rk,c} = V_{Rk,pb}$$

- Verifiable calculation notes and drawings have to be prepared taking account the relevant masonry in the region of the anchorage, the loads to be transmitted and their transmission to the supports of the structure. The position of the anchor is indicated on the design drawings

### Installation:

- Category d/d: -Installation and use in dry structures
- Category w/w: -Installation and use in dry and wet structures
- Hole drilling by hammer drill mode
- In case of aborted hole: The hole shall be filled with mortar
- Bridging of unbearing layer (e.g. plaster) see Annex B 4 (Table B1.3)
- Anchor installation carried out by appropriately qualified personnel and under the supervision of the person responsible for technical matters of the site
- Fastening screws or threaded rods (including nut and washer) must comply with the appropriate material and property class of the fischer internal threaded anchor FIS E
- minimum curing time see Annex B5. Table B3
- Commercial standard threaded rods, washers and hexagon nuts may also be used if the following requirements are fulfilled:

Material dimensions and mechanical properties of the metal parts according to the specifications are given in Annex A4, Table A1

Conformation of material and mechanical properties of the metal parts by inspection certificate 3.1 according to EN 10204:2004, the documents shall be stored

Marking of the threaded rod with the envisage embedment depth. This may be done by the manufacturer of the rod **or** by a person on job site

**fischer Injectionsystem FIS P Plus for masonry**

**Intended Use**  
Specifications part 2

**Annex B 2**

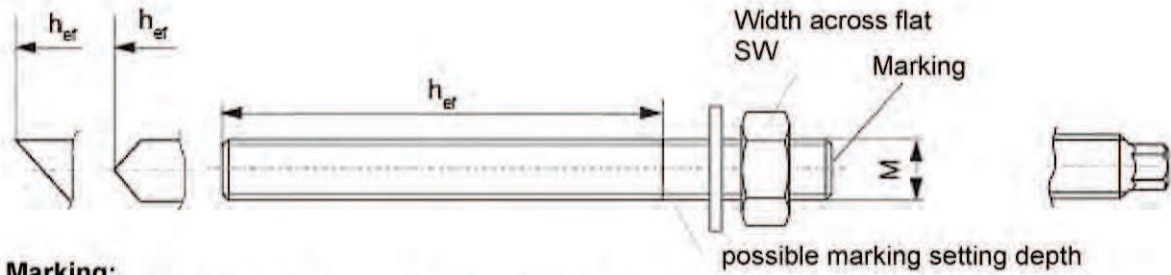

**Marking:**

Property class 8.8 or high corrosion-resistant steel C, property class 80: •  
 Stainless steel A4, property class 50 and high corrosion-resistant steel C, property class 50: ••

**Table B1.1: Installation parameters for threaded rod without perforated sleeve**

| Size   |  | M8                     | M10 | M12 |
|--|--|------------------------|-----|-----|
| Nominal drill hole diameter                        | $d_{nom}=d_0$ [mm]                     | 10                     | 12  | 14  |
| Width across flat                                  | SW [mm]                                | 13                     | 17  | 19  |
| Effective anchorage depth <sup>1)</sup>            | $h_{ef,min}$ [mm]                      | 50                     |     |     |
| Depth of drill hole $h_0 = h_{ef}$                 | $h_{ef,max}$ [mm]                      | h-30 and $\leq 200$ mm |     |     |
| Effective anchorage depth AAC                      | $h_{ef,min}$ [mm]                      | 100                    |     |     |
|  | $h_{ef,max}$ [mm]                      | 120                    |     |     |
| Maximum torque moment                              | $T_{inst,max}$ [Nm]                    | 10                     |     |     |
| Max. torque moment for autoclaved aerated concrete | $T_{inst,max}$ [Nm]                    | 1                      | 2   |     |
| Diameter of clearance hole in the fixture          | Pre-position anchorage $d_f \leq$ [mm] | 9                      | 12  | 14  |
|  | Push through anchorage $d_f \leq$ [mm] | 11                     | 14  | 16  |

<sup>1)</sup>  $h_{ef,min} \leq h_{ef} \leq h_{ef,max}$  is possible.

**fischer internal threaded anchor FIS E**

FIS E 11x85 M6, FIS E 11x85 M8

FIS E 15x85 M10, FIS E 15x85 M12

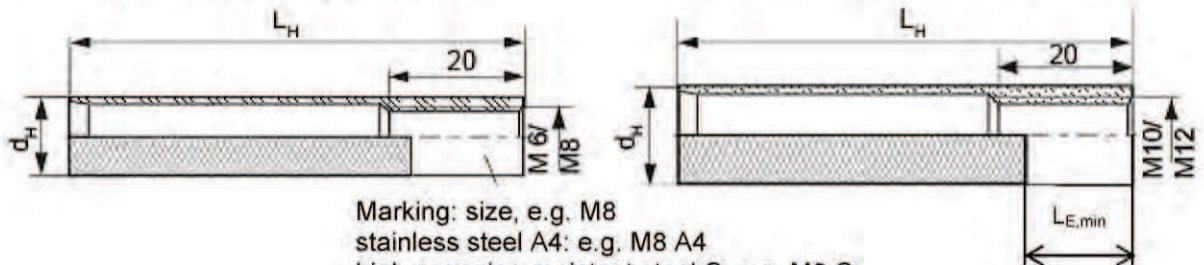

Marking: size, e.g. M8  
 stainless steel A4: e.g. M8 A4  
 high corrosion-resistant steel C: e.g. M8 C

**Table B1.2: Installation parameters for internal threaded anchor FIS E without perforated sleeve**

| Size FIS E   |                                 | M6 | M8 | M10 | M12 |
|--|---------------------------------|----|----|-----|-----|
| diameter of internal threaded anchor               | $d_H$ [mm]                      | 11 |    | 15  |     |
| Nominal drill hole diameter                        | $d_{nom}=d_0$ [mm]              | 14 |    | 18  |     |
| Depth of drill hole                                | $h_0$ [mm]                      | 85 |    |     |     |
| Effective anchorage depth                          | $L_H=h_{ef}$ [mm]               | 85 |    |     |     |
| Maximum torque moment                              | $T_{inst,max}$ [Nm]             | 4  | 10 |     |     |
| Max. torque moment for autoclaved aerated concrete | $T_{inst,max}$ [Nm]             | 1  |    | 2   |     |
| Diameter of clearance hole in the fixture          | $d_f \leq$ [mm]                 | 7  | 9  | 12  | 14  |
|  | Screw-in depth $L_{E,min}$ [mm] | 6  | 8  | 10  | 12  |

fischer Injectionsystem FIS P Plus for masonry

Intended Use  
 Installation parameters, part 1

Annex B 3

**Perforated sleeves FIS H 12x85; 16x85; 16x130; 20x85; 20x130; 20x200 K**

Marking: size  
 $D_{\text{Sleeve}} \times L_{\text{Sleeve}}$   
 e.g. 16x85

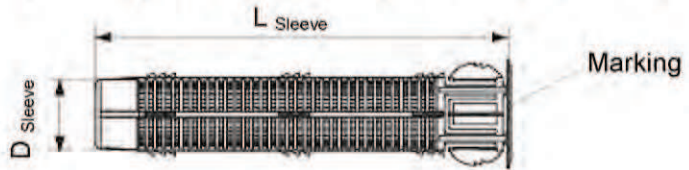

**Table B1.3: Installation parameters (threaded rod and internal threaded anchor with perforated sleeve; only pre-positioned anchorage)**

| Size FIS H...K  | 12x85                      | 16x85 | 16x130 <sup>2)</sup>    | 20x85 | 20x130 <sup>2)</sup>      | 20x200 <sup>2)</sup> |     |
|---|----------------------------|-------|-------------------------|-------|---------------------------|----------------------|-----|
| Nominal drill hole diameter ( $d_0 = D_{\text{Sleeve}}$ )       | $d_{\text{nom}}=d_0$ [mm]  | 12    | 16                      |       | 20                        |                      |     |
| Depth of drill hole   | $h_0$ [mm]                 | 90    | 90                      | 135   | 90                        | 135                  | 205 |
| Effective anchorage depth <sup>1)</sup>                         | $h_{\text{ef,min}}$ [mm]   | 85    | 85                      | 110   | 85                        | 110                  | 180 |
|   | $h_{\text{ef,max}}$ [mm]   | 85    | 85                      | 130   | 85                        | 130                  | 200 |
| Size of threaded rod  | [-]                        | M8    | M8, M10                 |       | M12                       |                      |     |
| Size of internal threaded anchor                                | [-]                        | ---   | FIS E<br>11x85<br>M6/M8 | ---   | FIS E<br>15x85<br>M10/M12 | ---                  | --- |
| Maximum torque moment threaded rod and internal threaded anchor | $T_{\text{inst,max}}$ [mm] | 2     |                         |       |                           |                      |     |

<sup>1)</sup>  $h_{\text{ef,min}} \leq h_{\text{ef}} \leq h_{\text{ef,max}}$  is possible.

<sup>2)</sup> Bridging of unbearing layer (e.g. plaster) possible

**Steel brush BS**



Only for solid bricks and aerated concrete

**Table B2: Parameters of steel brush**

|                     |             |      |    |    |    |    |    |    |
|---------------------|-------------|------|----|----|----|----|----|----|
| Drill hole diameter | $d_0$       | [mm] | 10 | 12 | 14 | 16 | 18 | 20 |
| Brush diameter      | $d_{b,nom}$ | [mm] | 11 | 14 | 16 | 20 | 20 | 25 |

**Table B3: Maximum processing time of the mortar and minimum curing time**

(During the curing time of the mortar the masonry temperature may not fall below the listed minimum temperature).

| Temperature at anchoring base [ °C ] | Minimum curing time <sup>1)</sup> $t_{cure}$ [minutes] |                          |                                    |
|--------------------------------------|--|--------------------------|------------------------------------|
|                                      | FIS P Plus High Speed <sup>3)</sup>                    | FIS P Plus <sup>2)</sup> | FIS P Plus Low Speed <sup>2)</sup> |
| -10 to -5                            | 12 hours   |                          |                                    |
| >-5 to ±0                            | 3 hours  | 24 hours                 |                                    |
| >±0 to +5                            | 90   | 3 hours                  | 6 hours                            |
| >+5 to +10                           | 45   | 90                       | 3 hours                            |
| >+10 to +20                          | 30   | 60                       | 2 hours                            |
| >+20 to +30                          |  | 45                       | 60                                 |
| >+30 to +40                          |  | 35                       | 30                                 |

| System-temperature (mortar) [ °C ] | Maximum processing time $t_{work}$ [minutes] |                          |                                    |
|------------------------------------|--|--------------------------|------------------------------------|
|                                    | FIS P Plus High Speed <sup>3)</sup>          | FIS P Plus <sup>2)</sup> | FIS P Plus Low Speed <sup>2)</sup> |
| ±0                                 | 5  |                          |                                    |
| +5                                 | 5  | 13                       | 20                                 |
| +10                                | 3  | 9                        | 20                                 |
| +20                                | 1  | 5                        | 10                                 |
| +30                                |  | 4                        | 6                                  |
| +40                                |  | 2                        | 4                                  |

<sup>1)</sup> For wet bricks the curing time must be doubled

<sup>2)</sup> Minimum cartridge temperature +5°C

<sup>3)</sup> Minimum cartridge temperature ±0°C











fischer Injectionsystem FIS P Plus for masonry

Intended Use  
Steel brush  
Processing times and curing times

**Annex B 5**

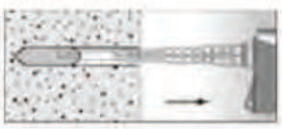
## Installation instructions part 1

### Installation and Preparing the cartridge in solid brick and autoclaved aerated concrete (without perforated sleeve)

|   |   |   |  |   |
|---|---|---|--|---|
| 1 |    | <p>Drill the hole. Depth of drill hole <math>h_0</math> and drill hole diameter <math>d_0</math> see Table <b>B1.1</b> or <b>B1.2</b></p>   |  |   |
| 2 |   | <p>Blow out the drill hole two times by hand. Brush the drill hole two times using an adequate steel brush (see Table B2) and blow out two times again</p>  |  |   |
| 3 |   | <p>Remove the sealing cap</p>   |   | <p>Screw on the static mixer (the spiral in the static mixer must be clearly visible)</p>   |
| 4 |  | <p>Place the cartridge into a suitable dispenser.</p>   |  | <p>Press out approximately 10 cm of material until the mortar is permanently grey in colour. Mortar which is not grey in colour will not cure and must be disposed off.</p> |
| 5 |  | <p>Fill approximately 2/3 of the drill hole with mortar. Always begin from the bottom of the hole to eliminate voids<sup>1)</sup>.</p>  |  | <p>For push through installation (not FIS E) fill the annular gap also with mortar.</p>   |
| 6 |  | <p>Only use clean and oil-free anchor elements. Mark the threaded rod for setting depth. Press the threaded rod or internal threaded anchor FIS E down to the bottom of the hole, turning it slightly by hand while doing. After inserting the anchor element, excess mortar must emerge around the anchor element.</p> |  |   |
| 7 |  | <p>Wait for the specified curing time <math>t_{cure}</math> see Table <b>B3</b></p>   |  | <p>Mounting the fixture <math>T_{inst,max}</math> see Table <b>B1.1</b> or <b>B1.2</b></p>  |

<sup>1)</sup> For the exact quantity of mortar see manufacturer's specification.

fischer Injectionsystem FIS P Plus for masonry









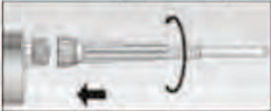

**Intended Use**

Installation instructions part 1 in solid brick and aerated concrete

**Annex B 6**

## Installation instructions part 2

### Installation in perforated or solid brick with perforated sleeve (pre-positioned anchorage)

|   |  |   |  |
|---|--|---|--|
| 1 |   | <p>Drill the hole. Depth of drill hole <math>h_0</math> and drill hole diameter <math>d_0</math> see Table B1.3</p> | <p>When install perforated sleeves in solid bricks or solid areas of hollow bricks, also clean the hole by blowing out and brushing</p>  |
| 2 |   | <p>Remove the sealing cap</p>   |  <p>Screw on the static mixer (the spiral in the static mixer must be clearly visible)</p>   |
| 3 |   | <p>Place the cartridge into a suitable dispenser</p>  |  <p>Press out approximately 10 cm of material until the mortar is permanently grey in colour. Mortar which is not grey in colour will not cure and must be disposed off</p>  |
| 4 |    | <p>Insert the perforated sleeve flush with the surface of the masonry or plaster .</p>                              |  <p>Fill the perforated sleeve completely with mortar beginning from the bottom of the hole<sup>1)</sup>.</p>   |
| 5 |   |   | <p>Only use clean and oil-free anchor elements. Mark the threaded rod for setting depth. Insert the threaded rod or the internal threaded anchor FIS E by hand using light turning motions until reaching the setting depth marking (threaded rod) or flush with the surface (internal threaded anchor).</p> |
| 6 |  <p>Wait for the specified curing time <math>t_{cure}</math> see Table B3</p> |   |  <p>Mounting the fixture. <math>T_{inst,max}</math> see Table B1.3</p>   |







<sup>1)</sup> For the exact quantity of mortar see manufacturer's specification.

fischer Injectionsystem FIS P Plus for masonry

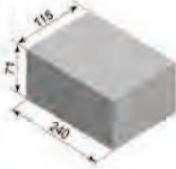
**Intended Use**  
Installation instructions part 2 in hollow brick masonry

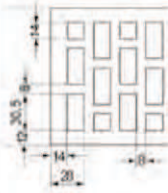
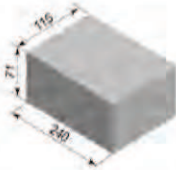
**Annex B 7**

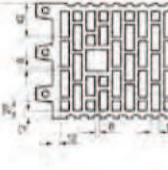
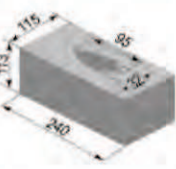
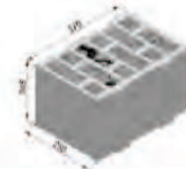
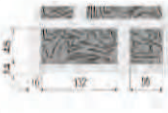
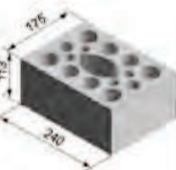
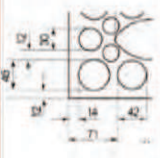
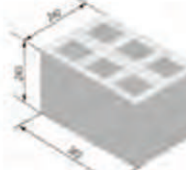
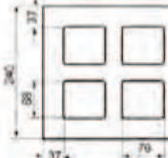
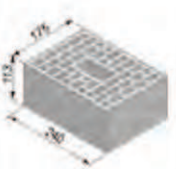
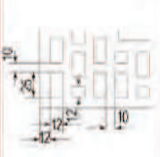
**Table B 4: Summary of bricks and blocks**

|   |   |   |   |   |   |
|---|---|---|---|---|---|
| <p><b>Brick No. 1</b><br/>Solid brick Mz according to EN 771-2<br/><math>\rho \geq 1,8</math> [kg/dm<sup>3</sup>]<br/><math>f_b \geq 10</math> or 20 [N/mm<sup>2</sup>]</p>         |    |   | <p><b>Brick No. 6</b><br/>Perforated brick HLz according to EN 771-1<br/><math>\rho \geq 1,4</math> [kg/dm<sup>3</sup>]<br/><math>f_b \geq 20</math> [N/mm<sup>2</sup>]</p>                         |    |    |
| <p><b>Brick No. 2</b><br/>Solid sand-lime brick according to EN 771-2<br/><math>\rho \geq 1,8</math> [kg/dm<sup>3</sup>]<br/><math>f_b \geq 10</math> or 20 [N/mm<sup>2</sup>]</p>  |    |   | <p><b>Brick No. 7</b><br/>Perforated brick HLz according to EN 771-1<br/><math>\rho \geq 1,0</math> [kg/dm<sup>3</sup>]<br/><math>f_b \geq 10</math> [N/mm<sup>2</sup>]</p>                         |    |    |
| <p><b>Brick No. 3</b><br/>Solid sand-lime brick according to EN 771-2<br/><math>\rho \geq 1,8</math> [kg/dm<sup>3</sup>]<br/><math>f_b \geq 10</math> or 20 [N/mm<sup>2</sup>]</p>  |    |   | <p><b>Brick No. 8</b><br/>Perforated brick HLz filled with mineral wool according to EN 771-1<br/><math>\rho \geq 0,6</math> [kg/dm<sup>3</sup>]<br/><math>f_b \geq 8</math> [N/mm<sup>2</sup>]</p> |    |    |
| <p><b>Brick No. 4</b><br/>Sand-lime hollow brick according to EN 771-2<br/><math>\rho \geq 1,4</math> [kg/dm<sup>3</sup>]<br/><math>f_b \geq 12</math> or 20 [N/mm<sup>2</sup>]</p> |  |  | <p><b>Brick-No. 9</b><br/>Light-weight concrete hollow block Hbl according to EN 771-1<br/><math>\rho \geq 1,0</math> [kg/dm<sup>3</sup>]<br/><math>f_b \geq 4</math> [N/mm<sup>2</sup>]</p>        |  |  |
| <p><b>Brick No. 5</b><br/>Perforated brick HLz according to EN 771-1<br/><math>\rho \geq 0,9</math> [kg/dm<sup>3</sup>]<br/><math>f_b \geq 10</math> [N/mm<sup>2</sup>]</p>         |  |  | <p><b>Brick No. 10</b><br/>Autoclaved aerated concrete block<br/><math>\rho \geq 350, 500</math> or 650 [kg/dm<sup>3</sup>]<br/><math>f_b \geq 2, 4</math> or 6 [N/mm<sup>2</sup>]</p>              |  |   |







Imaging of the bricks are not scaled

fischer Injectionsystem FIS P Plus for masonry

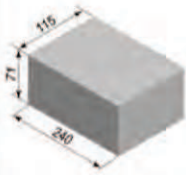
**Intended Use**  
Types and dimensions of blocks and bricks

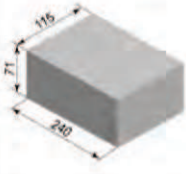
**Annex B 8**

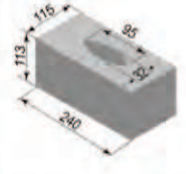
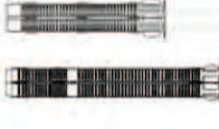
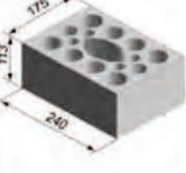
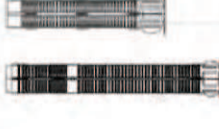
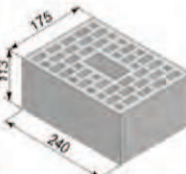
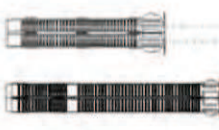
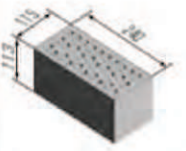
**Table B5.1: Allocation of threaded rods<sup>1)</sup>, perforated sleeves<sup>1)2)</sup> and perforated or solid bricks**

| Kind of masonry   | Brick   | Valid anchor rods and perforated sleeves  |   |
|---|---|---|---|
| <b>Brick No. 1</b><br>Solid brick Mz according to EN 771-2<br>$\rho \geq 1,8$ [kg/dm <sup>3</sup> ]<br>$f_b \geq 10$ or 20 [N/mm <sup>2</sup> ]         |    |    | M8; M10; M12<br><br>FIS E 11x85<br>M6, M8   |
| <b>Brick No. 2</b><br>Solid sand-lime brick according to EN 771-2<br>$\rho \geq 1,8$ [kg/dm <sup>3</sup> ]<br>$f_b \geq 10$ or 20 [N/mm <sup>2</sup> ]  |    |    | M8; M10; M12<br><br>FIS E 11x85<br>M6, M8   |
| <b>Brick No. 3</b><br>Solid sand-lime brick according to EN 771-2<br>$\rho \geq 1,8$ [kg/dm <sup>3</sup> ]<br>$f_b \geq 10$ or 20 [N/mm <sup>2</sup> ]  |   |   | FIS H 12x85 K<br>FIS H 16x85 K<br>FIS H 20x85 K<br>FIS H 16x130 K<br>FIS H 20x130 K |
| <b>Brick No. 4</b><br>Sand-lime hollow brick according to EN 771-2<br>$\rho \geq 1,4$ [kg/dm <sup>3</sup> ]<br>$f_b \geq 12$ or 20 [N/mm <sup>2</sup> ] |  |  | FIS H 12x85 K<br>FIS H 16x85 K<br>FIS H 20x85 K<br>FIS H 16x130 K<br>FIS H 20x130 K |
| <b>Brick No. 5</b><br>Perforated brick HLz according to EN 771-1<br>$\rho \geq 0,9$ [kg/dm <sup>3</sup> ]<br>$f_b \geq 10$ [N/mm <sup>2</sup> ]         |  |  | FIS H 12x85 K<br>FIS H 16x85 K<br>FIS H 20x85 K<br>FIS H 16x130 K<br>FIS H 20x130 K |
| <b>Brick No. 6</b><br>Perforated brick HLz according to EN 771-1<br>$\rho \geq 1,4$ [kg/dm <sup>3</sup> ]<br>$f_b \geq 20$ [N/mm <sup>2</sup> ]         |  |  | FIS H 12x85 K<br>FIS H 16x85 K<br>FIS H 20x85 K                                     |

<sup>1)</sup> Other combinations can be used after job site tests acc. to ETAG 029, Annex B.

<sup>2)</sup> Sleeve/anchor rod combination see table B1.3

The  $\beta$ - factor for this job site tests are given in Table C4

Imaging of the bricks are not scaled

**fischer Injectionsystem FIS P Plus for masonry**







**Intended Use**

Allocation of threaded rods, perforated sleeves and bricks, part 1

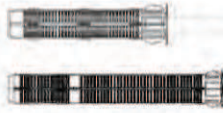
**Annex B 9**

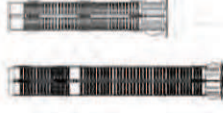
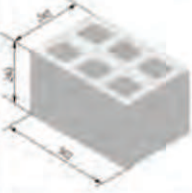

**Table B5.2: Allocation of threaded rods<sup>1)</sup>, perforated sleeves<sup>1)2)</sup> and perforated or solid bricks**

| Kind of masonry   | Brick   | Valid anchor rods and perforated sleeves  |   |
|---|---|---|---|
| <b>Brick No. 7</b><br>Perforated brick HLz according to EN 771-1<br>$\rho \geq 1,0$ [kg/dm <sup>3</sup> ]<br>$f_b \geq 10$ [N/mm <sup>2</sup> ]                         |    |    | FIS H 12x85 K<br>FIS H 16x85 K<br>FIS H 20x85 K<br>FIS H 20x130 K                                     |
| <b>Brick No. 8</b><br>Perforated brick HLz filled with mineral wool according to EN 771-1<br>$\rho \geq 0,6$ [kg/dm <sup>3</sup> ]<br>$f_b \geq 8$ [N/mm <sup>2</sup> ] |    |    | FIS H 12x85 K<br>FIS H 16x85 K<br>FIS H 20x85 K<br>FIS H 16x130 K<br>FIS H 20x130 K<br>FIS H 20x200 K |
| <b>Brick-No. 9</b><br>Light-weight concrete hollow block Hbl according to EN 771-1<br>$\rho \geq 1,0$ [kg/dm <sup>3</sup> ]<br>$f_b \geq 4$ [N/mm <sup>2</sup> ]        |   |   | FIS H 12x85 K<br>FIS H 16x85 K<br>FIS H 20x85 K<br>FIS H 16x130 K<br>FIS H 20x130 K                   |
| <b>Brick No. 10</b><br>Autoclaved aerated concrete block<br>$\rho \geq 350, 500$ or 650 [kg/dm <sup>3</sup> ]<br>$f_b \geq 2, 4$ or 6 [N/mm <sup>2</sup> ]              |  |  | M8; M10; M12  |
|   |   |   | FIS E 11x85 M6<br>FIS E 11x85 M8<br>FIS E 15x85 M10<br>FIS E 15x85 M12                                |

<sup>1)</sup> Other combinations can be used after job site tests acc. to ETAG 029, Annex B.

<sup>2)</sup> Sleeve/anchor rod combination see table B1.3

The  $\beta$ - factor for this job site tests are given in Table C4

Imaging of the bricks are not scaled

fischer Injectionsystem FIS P Plus for masonry

Intended Use

Allocation of threaded rods, perforated sleeves and bricks, part 2

Annex B 10

**Table C1.1: Characteristic values of resistance under tension loads and under shear loads**

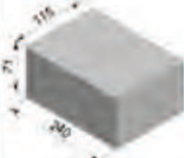
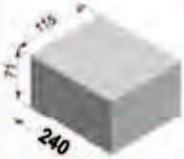
| Brick  | Density $\rho$<br>[kg/dm <sup>3</sup> ]<br>-<br>Compressive strength $f_b$<br>[N/mm <sup>2</sup> ] | Perforated sleeve<br>FIS H...K | Anchor size or screw<br>size in internal<br>threaded anchor | Effective anchorage depth |                      | Characteristic resistance [kN] |     |          |     |
|--|--|--------------------------------|---|---------------------------|----------------------|--------------------------------|-----|----------|-----|
|  |  |                                |   | $h_{ef,min}$<br>[mm]      | $h_{ef,max}$<br>[mm] | $N_{Rk}$                       |     | $V_{Rk}$ |     |
|  |  |                                |   |                           |                      | Temp.<br>50/80°C               |     |          |     |
|  |  |                                |   | d/d                       | w/w                  | All categories                 |     |          |     |
|  <p><b>No.1</b><br/>Solid brick Mz</p>              | $\rho \geq 1,8$<br>$f_b \geq 10$   | without                        | M8  | 50                        | 200                  | 4,0                            | 2,5 | 2,5      |     |
|  |  |                                | M10   | 50                        | 79                   | 3,5                            | 2,0 |          | 4,0 |
|  |  |                                | M10   | 80                        | 199                  | 5,0                            | 3,0 |          |     |
|  |  |                                | M10   | 200                       | 200                  | 8,5                            | 7,5 | 8,5      |     |
|  |  |                                | M12   | 50                        | 79                   | 3,0                            | 2,0 | 4,0      |     |
|  |  |                                | M12   | 80                        | 199                  | 5,5                            | 3,5 |          |     |
|  |  |                                | M12   | 200                       | 200                  | 8,0                            | 5,0 | 8,5      |     |
|  | FIS E 11x85 M6/ M8   |                                | 85  | 85                        | 5,5                  | 3,5                            | 2,5 |          |     |
|  | $\rho \geq 1,8$<br>$f_b \geq 20$   |                                | M8  | 50                        | 200                  | 5,5                            | 3,5 | 4,0      |     |
|  |  |                                | M10   | 50                        | 79                   | 5,0                            | 3,0 | 6,0      |     |
|  |  |                                | M10   | 80                        | 199                  | 7,0                            | 4,5 |          |     |
|  |  |                                | M10   | 200                       | 200                  | 8,5                            | 8,5 | 8,5      |     |
|  |  |                                | M12   | 50                        | 79                   | 4,5                            | 3,0 | 5,5      |     |
|  |  |                                | M12   | 80                        | 199                  | 8,0                            | 5,0 |          |     |
| M12  |  | 200                            | 200   | 8,5                       | 7,0                  | 8,5                            |     |          |     |
| FIS E 11x85 M6/ M8   | 85   | 85                             | 8,0   | 5,0                       | 4,0                  |                                |     |          |     |
|  <p><b>No.2</b><br/>Solid sand-lime<br/>brick</p> | $\rho \geq 1,8$<br>$f_b \geq 10$   | without                        | M8  | 50                        | 200                  | 2,5                            | 1,5 | 4,0      |     |
|  |  |                                | M10   | 50                        | 79                   |                                |     |          |     |
|  |  |                                | M10   | 80                        | 199                  |                                |     |          |     |
|  |  |                                | M10   | 200                       | 200                  | 8,5                            | 6,0 |          |     |
|  |  |                                | M12   | 50                        | 79                   | 2,5                            | 1,5 | 5,0      |     |
|  |  |                                | M12   | 80                        | 199                  |                                |     |          |     |
|  |  |                                | M12   | 200                       | 200                  | 8,5                            | 6,5 |          |     |
|  | FIS E 11x85 M6/ M8   |                                | 85  | 85                        | 2,5                  | 1,5                            | 3,0 |          |     |
|  | $\rho \geq 1,8$<br>$f_b \geq 20$   |                                | M8  | 50                        | 200                  | 3,5                            | 2,0 | 5,5      |     |
|  |  |                                | M10   | 50                        | 79                   |                                |     |          |     |
|  |  |                                | M10   | 80                        | 199                  |                                |     |          |     |
|  |  |                                | M10   | 200                       | 200                  | 8,5                            | 8,5 |          |     |
|  |  |                                | M12   | 50                        | 79                   | 3,5                            | 2,0 | 7,0      |     |
|  |  |                                | M12   | 80                        | 199                  |                                |     |          |     |
| M12  |  | 200                            | 200   | 8,5                       | 8,5                  |                                |     |          |     |
| FIS E 11x85 M6/ M8   | 85   | 85                             | 3,5   | 2,0                       | 4,0                  |                                |     |          |     |

Imaging of the bricks are not scaled

fischer Injectionsystem FIS P Plus for masonry

**Performances**  
Characteristic values of resistance under tension loads and under shear loads, part 1

**Annex C 1**

**Table C1.2: Characteristic values of resistance under tension loads and under shear loads**

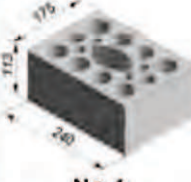
| Brick   | Density $\rho$<br>[kg/dm <sup>3</sup> ]<br>-<br>Compressive<br>strength $f_b$<br>[N/mm <sup>2</sup> ] | Perforated<br>sleeve<br>FIS H...K | Anchor size or<br>screw size in<br>internal threaded<br>anchor | Effective<br>anchorage<br>depth |                      | Characteristic resistance<br>[kN] |     |                 |
|---|---|-----------------------------------|--|---------------------------------|----------------------|-----------------------------------|-----|-----------------|
|   |   |                                   |  | $h_{ef,min}$<br>[mm]            | $h_{ef,max}$<br>[mm] | N <sub>Rk</sub>                   |     | V <sub>Rk</sub> |
|   |   |                                   |  |                                 |                      | Temp.<br>50/80°C                  |     |                 |
|   |   |                                   |  | d/d                             | w/w                  | All categories                    |     |                 |
|  <p><b>No.3</b><br/>Solid sand-lime<br/>brick</p>    | $\rho \geq 1,8$<br>$f_b \geq 10$  | 12x85                             | M8   | 85                              | 85                   | 6,0                               | 3,5 | 3,0             |
|   |   | 16x85                             | FIS E 11x85 M6   | 85                              | 85                   | 3,5                               | 2,0 |                 |
|   |   | 16x85                             | M8/M10,<br>FIS E 11x85 M8                                      | 85                              | 85                   | 3,5                               | 2,0 | 3,5             |
|   |   | 20x85                             | M12,<br>FIS E 15x85<br>M10/M12                                 | 85                              | 85                   | 8,5                               | 6,5 |                 |
|   |   | 16x130                            | M8/M10   | 110                             | 130                  | 3,5                               | 2,0 |                 |
|   |   | 20x130                            | M12  | 110                             | 130                  | 7,0                               | 4,5 |                 |
|   | $\rho \geq 1,8$<br>$f_b \geq 20$  | 12x85                             | M8   | 85                              | 85                   | 8,5                               | 5,0 | 4,5             |
|   |   | 16x85                             | FIS E 11x85 M6   | 85                              | 85                   | 5,5                               | 3,0 |                 |
|   |   | 16x85                             | M8/M10,<br>FIS E 11x85 M8                                      | 85                              | 85                   | 5,5                               | 3,0 | 5,5             |
|   |   | 20x85                             | M12,<br>FIS E 15x85<br>M10/M12                                 | 85                              | 85                   | 8,5                               | 8,5 |                 |
|   |   | 16x130                            | M8/M10   | 110                             | 130                  | 5,0                               | 3,0 |                 |
|   |   | 20x130                            | M12  | 110                             | 130                  | 8,5                               | 6,0 |                 |
|  <p><b>No.4</b><br/>Sand-lime hollow<br/>brick</p> | $\rho \geq 1,4$<br>$f_b \geq 12$  | 12x85                             | M8   | 85                              | 85                   | 2,5                               | 2,5 | 2,5             |
|   |   | 16x85                             | FIS E 11x85 M6   | 85                              | 85                   | 3,0                               | 2,5 |                 |
|   |   | 16x85                             | M8/M10,<br>FIS E 11x85 M8                                      | 85                              | 85                   | 3,0                               | 2,5 | 4,5             |
|   |   | 20x85                             | M12,<br>FIS E 15x85<br>M10/M12                                 | 85                              | 85                   | 3,5                               | 3,0 | 4,5             |
|   |   | 16x130                            | M8/M10   | 110                             | 130                  |                                   |     |                 |
|   |   | 20x130                            | M12  | 110                             | 130                  |                                   |     |                 |
|   | $\rho \geq 1,4$<br>$f_b \geq 20$  | 12x85                             | M8   | 85                              | 85                   | 4,5                               | 4,0 | 4,5             |
|   |   | 16x85                             | FIS E 11x85 M6   | 85                              | 85                   | 5,0                               | 4,0 | 4,0             |
|   |   | 16x85                             | M8/M10,<br>FIS E 11x85 M8                                      | 85                              | 85                   | 5,0                               | 4,5 | 7,5             |
|   |   | 20x85                             | M12,<br>FIS E 15x85<br>M10/M12                                 | 85                              | 85                   | 6,0                               | 5,5 | 7,5             |
|   |   | 16x130                            | M8/M10   | 110                             | 130                  |                                   |     |                 |
|   |   | 20x130                            | M12  | 110                             | 130                  |                                   |     |                 |

Imaging of the bricks are not scaled





fischer Injectionsystem FIS P Plus for masonry

**Performances**

Characteristic values of resistance under tension loads and under shear loads, part 2

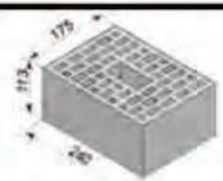
**Annex C 2**

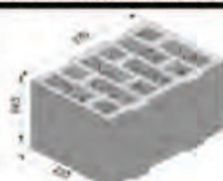
**Table C1.3: Characteristic values of resistance under tension loads and under shear loads**

| Brick   | Density $\rho$<br>[kg/dm <sup>3</sup> ]<br>-<br>Compressive strength $f_b$<br>[N/mm <sup>2</sup> ] | Perforated sleeve<br>FIS H...K | Anchor size or screw size<br>in internal threaded<br>anchor | Effective anchorage depth |                      | Characteristic resistance [kN] |     |                         |
|---|--|--------------------------------|---|---------------------------|----------------------|--------------------------------|-----|-------------------------|
|   |  |                                |   | $h_{ef,min}$<br>[mm]      | $h_{ef,max}$<br>[mm] | N <sub>Rk</sub>                |     | V <sub>Rk</sub>         |
|   |  |                                |   |                           |                      | Temp.<br>50/80°C               |     | All<br>categories       |
|   |  |                                |   |                           |                      | d/d                            | w/w |                         |
| <br>No.5 Perforated brick HLz                    | $\rho \geq 0,9$<br>$f_b \geq 10$   | 12x85                          | M8  | 85                        | 85                   | 4,0                            | 3,5 | 4,0                     |
|   |  | 16x85                          | FIS E 11x85 M6  | 85                        | 85                   | 3,5                            | 3,5 | 4,0                     |
|   |  | 16x85                          | M8/M10,<br>FIS E 11x85 M8                                   | 85                        | 85                   | 3,5                            | 3,5 | 5,5                     |
|   |  | 20x85                          | M12, FIS E 15x85 M10/M12                                    | 85                        | 85                   | 5,0                            | 4,5 | 6,0                     |
|   |  | 16x130                         | M8/M10  | 130                       | 130                  | 5,0                            | 4,5 | 5,5                     |
|   |  | 20x130                         | M12   | 110                       | 130                  | 5,0                            | 4,5 | 6,0                     |
| <br>No.6 Perforated brick HLz                   | $\rho \geq 1,4$<br>$f_b \geq 20$   | 12x85                          | M8  | 85                        | 85                   | 4,0                            | 3,5 | 7,5 (5,5) <sup>1)</sup> |
|   |  | 16x85                          | FIS E 11x85 M6  | 85                        | 85                   | 2,5                            |     | 4,0                     |
|   |  | 16x85                          | M8/M10,<br>FIS E 11x85 M8                                   | 85                        | 85                   | 2,5                            |     | 4,5                     |
|   |  | 20x85                          | M12, FIS E 15x85 M10/M12                                    | 85                        | 85                   | 3,0                            |     | 8,5 (5,5) <sup>1)</sup> |
| <br>No.7 Perforated brick HLz                  | $\rho \geq 1,0$<br>$f_b \geq 10$   | 12x85                          | M8  | 85                        | 85                   | 0,9                            |     | 1,2                     |
|   |  | 16x85                          | M8/M10,<br>FIS E 11x85 M6/M8                                | 85                        | 85                   | 2,5                            |     |                         |
|   |  | 20x85                          | M12, FIS E 15x85 M10/M12                                    | 85                        | 85                   | 2,5                            |     | 1,5                     |
|   |  | 16x130                         | M8/M10  | 110                       | 130                  | 2,5                            |     |                         |
|   |  | 20x130                         | M12   | 110                       | 130                  | 3,5                            | 3,0 |                         |
| <br>No.8 Perforated brick HLz                  | $\rho \geq 0,6$<br>$f_b \geq 8$  | 12x85                          | M8  | 85                        | 85                   | 2,0                            | 2,0 | 2,5                     |
|   |  | 16x85                          | FIS E 11x85 M6  | 85                        | 85                   | 2,0                            | 1,5 | 2,5                     |
|   |  | 16x85                          | M8/M10,<br>FIS E 11x85 M8                                   | 85                        | 85                   | 2,0                            | 1,5 | 3,0                     |
|   |  | 20x85                          | M12, FIS E 15x85 M10/M12                                    | 85                        | 85                   | 2,0                            | 2,0 | 1,5                     |
|   |  | 16x130                         | M8/M10  | 130                       | 130                  | 3,0                            | 2,5 | 3,0                     |
|   |  | 20x130                         | M12   | 110                       | 130                  | 2,0                            | 2,0 | 1,5                     |
|   |  | 20x200                         | M12   | 180                       | 200                  | 3,0                            | 3,0 | 1,5                     |
| <br>No.9 Light-weight<br>concrete hollow block | $\rho \geq 1,0$<br>$f_b \geq 4$  | 12x85                          | M8  | 85                        | 85                   | 3,0                            |     | 2,0                     |
|   |  | 16x85                          | M8/M10,<br>FIS E 11x85 M6/M8                                | 85                        | 85                   | 3,0                            |     |                         |
|   |  | 20x85                          | M12, FIS E 15x85 M10/M12                                    | 85                        | 85                   | 3,0                            |     |                         |
|   |  | 16x130                         | M8/M10  | 130                       | 130                  | 3,0                            |     |                         |
|   |  | 20x130                         | M12   | 110                       | 130                  | 3,0                            |     |                         |

<sup>1)</sup> Characteristic value of pushing out of one brick  $V_{Rk,pb} = 5,5$  kN  
Imaging of the bricks are not scaled

**fischer Injectionsystem FIS P Plus for masonry**

**Performances**  
Characteristic values of resistance under tension loads and under shear loads, part 3

**Annex C 3**

**Table C1.4: Characteristic values of resistance under tension loads and under shear loads**

| Brick   | Density $\rho$<br>[kg/dm <sup>3</sup> ]<br>-<br>Compressive strength $f_b$<br>[N/mm <sup>2</sup> ] | Perforated sleeve<br>FIS H...K | Anchor size or screw size in internal threaded anchor | Effective anchorage depth |                      | Characteristic resistance [kN] |                |                 |     |
|---|--|--------------------------------|---|---------------------------|----------------------|--------------------------------|----------------|-----------------|-----|
|   |  |                                |   | $h_{ef,min}$<br>[mm]      | $h_{ef,max}$<br>[mm] | N <sub>Rk</sub>                |                | V <sub>Rk</sub> |     |
|   |  |                                |   |                           |                      | Temp. 50/80°C                  |                |                 |     |
|   |  |                                |   |                           |                      | d/d                            | w/w            |                 |     |
|   |  |                                |   |                           |                      |                                | All categories |                 |     |
|  <p><b>No.10</b> Aerated concrete block</p> | $\rho \geq 350$<br>$f_b \geq 2$  | ohne                           | M8  | 100                       | 120                  | 1,5                            |                | 1,2             |     |
|   |  |                                | M10   | 100                       | 120                  |                                |                | 1,2             |     |
|   |  |                                | M12   | 100                       | 120                  |                                |                | 1,5             |     |
|   |  |                                | FIS E 11x85<br>M6/M8<br>FIS E 15x85<br>M10/M12        | 85                        |                      |                                |                | 1,2             |     |
|   | $\rho \geq 500$<br>$f_b \geq 4$  | ohne                           | M8  | 100                       | 120                  | 2,0                            | 2,5            | 2,5             |     |
|   |  |                                | M10   | 100                       | 120                  | 2,0                            |                |                 |     |
|   |  |                                | M12   | 100                       | 120                  | 2,5                            |                |                 |     |
|   |  |                                | FIS E 11x85<br>M6/M8<br>FIS E 15x85<br>M10/M12        | 85                        |                      | 2,0                            | 2,0            |                 |     |
|   | $\rho \geq 650$<br>$f_b \geq 6$  | ohne                           | M8  | 100                       | 120                  | 3,5                            | 5,0            | 4,5             | 3,0 |
|   |  |                                | M10   | 100                       | 120                  | 3,0                            |                |                 |     |
|   |  |                                | M12   | 100                       | 120                  | 3,5                            |                |                 |     |
|   |  |                                | FIS E 11x85<br>M6/M8<br>FIS E 15x85<br>M10/M12        | 85                        |                      | 3,5                            | 2,5            |                 |     |

Imaging of the bricks are not scaled

fischer Injectionsystem FIS P Plus for masonry

**Performances**

Characteristic values of resistance under tension loads and under shear loads, part 4

**Annex C 4**

**Table C2: Characteristic bending moments**

| Size                                     |                                  |                |                       | M8 | M10 | M12 |
|--|----------------------------------|----------------|-----------------------|----|-----|-----|
| Characteristic bending moment $M_{Rk,s}$ | Zinc-plated steel                | Property class | 5.8 [Nm]              | 19 | 37  | 65  |
|  |                                  |                | 8.8 [Nm]              | 30 | 60  | 105 |
|  | Stainless steel A4               | Property class | 50 [Nm]               | 19 | 37  | 65  |
|  |                                  |                | 70 [Nm]               | 26 | 52  | 92  |
|  |                                  |                | 80 [Nm]               | 30 | 60  | 105 |
|  | High corrosion-resistant steel C | Property class | 50 [Nm]               | 19 | 37  | 65  |
|  |                                  |                | 70 <sup>1)</sup> [Nm] | 26 | 52  | 92  |
|  |                                  |                | 80 [Nm]               | 30 | 60  | 105 |

<sup>1)</sup>  $f_{uk}= 700 \text{ N/mm}^2$ ;  $f_{yk}=560 \text{ N/mm}^2$

**Table C2.1: Characteristic bending moments for internal threaded anchors FIS E**

| Size FIS E                                |                    |                         |                                  | M6                      | M8      | M10 | M12 |
|---|--------------------|-------------------------|----------------------------------|-------------------------|---------|-----|-----|
| Characteristic bending moments $M_{Rk,s}$ | zinc plated steel, | Property class of screw | 5.8 [Nm]                         | 8                       | 19      | 37  | 65  |
|   |                    |                         | 8.8 [Nm]                         | 12                      | 30      | 60  | 105 |
|   | stainless steel A4 | Property class of screw | 70 [Nm]                          | 11                      | 26      | 52  | 92  |
|   |                    |                         | high corrosion resistant steel C | Property class of screw | 70 [Nm] | 11  | 26  |

**Tabelle C3: Displacements under tension loads and shear loads**

| Material                                    | N [kN]                          | $\delta N_0$ [mm] | $\delta N_\infty$ [mm] | V [kN]                          | $\delta V_0$ [mm] | $\delta V_\infty$ [mm] |
|---|---------------------------------|-------------------|------------------------|---------------------------------|-------------------|------------------------|
| solid units and autoclaved aerated concrete | $\frac{N_{RK}}{1,4 * \gamma_M}$ | 0,03              | 0,06                   | $\frac{V_{RK}}{1,4 * \gamma_M}$ | 0,59              | 0,88                   |
|   | $\frac{N_{RK}}{1,4 * \gamma_M}$ | 0,03              | 0,06                   | $\frac{V_{RK}}{1,4 * \gamma_M}$ | 1,71              | 2,56                   |

fischer Injectionsystem FIS P Plus for masonry

**Performances**  
Characteristic bending moments; displacements

**Annex C 5**

**Table C4:  $\beta$ - factor for job site tests according to ETAG 029, Annex B**

| Using categories            |   | w/w   | d/d   |
|-----------------------------|---|-------|-------|
| Temperature range [°C]      |   | 50/80 | 50/80 |
| Brick                       | Size <sup>1)</sup>  |       |       |
| Solid brick                 | M8  | 0,57  | 0,96  |
|                             | M10   | 0,59  |       |
|                             | M12<br>FIS E 11x85<br>M6 / M8<br>FIS E 15x85<br>M10 / M12 | 0,60  |       |
| Hollow brick                | All sizes   | 0,86  | 0,96  |
| Autoclaved aerated concrete | All size  | 0,73  | 0,81  |

fischer Injectionsystem FIS P Plus for masonry

**Performances**  
 $\beta$ - factors for job site tests

**Annex C 6**

**Table C5: Edge distance and spacing (installation with and without sleeves)**

| Direction to bed joint |                         | ⊥                                  |                  | ∥                |                  | Group factor               |                  |                  |                  | Min. thickness of the masonry members<br>[mm] |
|------------------------|-------------------------|------------------------------------|------------------|------------------|------------------|----------------------------|------------------|------------------|------------------|---|
| Brick No.              | h <sub>ef</sub><br>[mm] | c <sub>cr</sub> = c <sub>min</sub> | s <sub>min</sub> | s <sub>cr</sub>  | s <sub>min</sub> | s <sub>cr</sub>            | ⊥                |                  | ∥                |   |
|                        |                         | [mm]                               | [mm]             | [mm]             | [mm]             | [mm]                       | α <sub>g,N</sub> | α <sub>g,V</sub> | α <sub>g,N</sub> | α <sub>g,V</sub>                              |
| 1                      | 50                      | 100                                | 75               | 60 <sup>1)</sup> | 150              | 2                          | 2                | 1,5              | 1,4              | h <sub>ef</sub> + 30<br>(≥ 80)                |
|                        | 80                      | 100                                | 75               | 60 <sup>1)</sup> | 240              | 2                          | 2                | 1,5              | 1,4              |   |
|                        | 200                     | 150                                | 75               | 240              |                  | 2                          |                  |                  |                  |   |
| 2                      | 50                      | 100                                | 75               | 240              |                  | 2                          |                  |                  |                  |   |
|                        | 80                      | 100                                | 75               | 240              |                  | 2                          |                  |                  |                  |   |
|                        | 200                     | 150                                | 75               | 240              |                  | 2                          |                  |                  |                  |   |
| 3                      | 85                      | 100                                | 115              | 240              |                  | 2                          |                  |                  |                  |   |
|                        | 130                     | 100                                | 115              | 240              |                  | 2                          |                  |                  |                  |   |
| 4                      | all sizes               | 100                                | 115              | 100              | 240              | 2                          | 2                | 1,5              | 1,5              |   |
| 5                      | all sizes               | 100                                | 115              | 240              |                  | 2                          |                  |                  |                  |   |
| 6                      | all sizes               | 100                                | 115              | 240              |                  | 2                          |                  |                  |                  |   |
| 7                      | all sizes               | 100                                | 100              | 240              | 100              | 375<br>(500) <sup>2)</sup> | 1                | 1                | 1                | 1   |
| 8                      | all sizes               | 120                                | 245              |                  | 250              |                            | 2                |                  |                  |   |
| 9                      | all sizes               | 80                                 | 240              |                  | 365              |                            | 2                |                  |                  |   |
| 10                     | all sizes               | 100                                | 250              |                  | 300              |                            | 2                |                  |                  |   |

<sup>1)</sup> only valid for tension loads, for shear loads s<sub>min</sub> ∥ = s<sub>cr</sub> ∥

<sup>2)</sup> spacing for alternative brick dimension, see table B4, brick 7

fischer Injectionsystem FIS P Plus for masonry

**Performances**  
Edge distance and spacing

**Annex C 7**



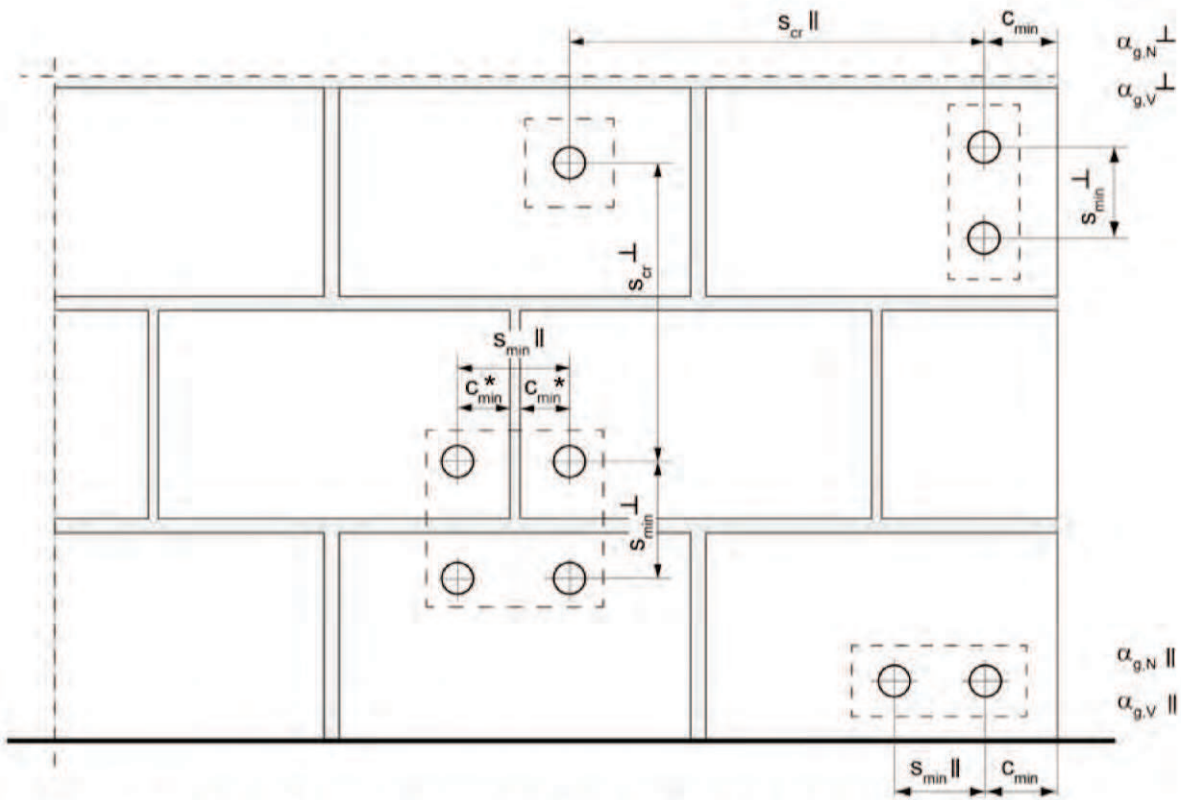

\* Only, if joints are visible and/or vertical joints are not filled with mortar

- $s_{min \parallel}$  = Minimum spacing parallel to bed joint
- $s_{min \perp}$  = Minimum spacing vertical to bed joint
- $s_{cr \parallel}$  = Characteristic spacing parallel to bed joint
- $s_{cr \perp}$  = Characteristic spacing vertical to bed joint
- $c_{cr} = c_{min}$  = Edge distance
- $\alpha_{g,N \parallel}$  = Group factor for tension load parallel to bed joint
- $\alpha_{g,V \parallel}$  = Group factor for shear load parallel to bed joint
- $\alpha_{g,N \perp}$  = Group factor for tension load vertical to bed joint
- $\alpha_{g,V \perp}$  = Group factor for shear load vertical to bed joint

For  $s > s_{cr}$   $\alpha_g = 2$

For  $s_{min} \leq s \leq s_{cr}$   $\alpha_g$  according to table C5

$$N_{Rk}^g = \alpha_{g,N} \cdot N_{Rk}; \quad V_{Rk}^g = \alpha_{g,V} \cdot V_{Rk} \quad (\text{Group of 2 anchors})$$

$$N_{Rk}^g = \alpha_{g,N \parallel} \cdot \alpha_{g,N \perp} \cdot N_{Rk}; \quad V_{Rk}^g = \alpha_{g,V \parallel} \cdot \alpha_{g,V \perp} \cdot V_{Rk} \quad (\text{Group of 4 anchors})$$

**fischer Injectionsystem FIS P Plus for masonry**

**Annex C 8**

**Performance**

Definition of minimum edge distance, minimum spacing and group factors